

**INSTALLATION INSTRUCTIONS**

**WARNINGS AND CAUTIONS:**

- **TO AVOID FIRE SHOCK OR DEATH; TURN OFF POWER** at circuit breaker or fuse when servicing, installing or removing fixture.
- To be installed and/or used in accordance with electrical codes and regulations.
- If you are unsure about any part of these instructions, consult an electrician.
- vizia +™ electronic switches are not compatible with standard 3-way or 4-way switches. They must be used with compatible vizia +™ on/off remotes.

**WARNINGS AND CAUTIONS:**

- Recommended minimum wall box depth is 2-1/2".
- Use only one (1) vizia +™ digital timer switch in a multi-location circuit with up to 9 coordinating remote switches (without LEDs) or up to 4 matching remote switches (with LEDs).
- Maximum wire length from digital timer switch to all installed remotes cannot exceed 300 ft (90 m).
- Use this device with **copper or copper clad wire only**.

**Tools needed to install your Timer Switch**

- Slotted/Phillips Screwdriver
- Electrical Tape
- Pliers
- Pencil
- Cutters
- Ruler

**Changing the color of your device:**  
 Your device may include color options. To change color of the face, proceed as follows:

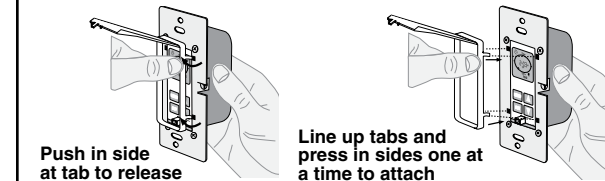

**Installing your Timer Switch**

**NOTE:** Use check boxes  when Steps are completed.

**Step 1 WARNING: TO AVOID FIRE SHOCK OR DEATH; TURN OFF POWER** at circuit breaker or fuse and test that power is off before wiring!

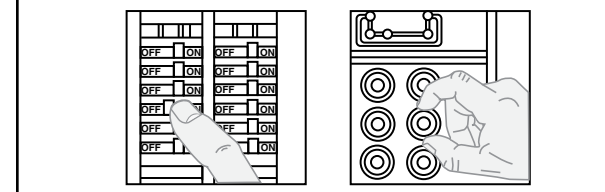

**Step 2 Identifying your wiring application (most common):**  
**NOTE:** If the wiring in your wall box does not resemble any of these configurations, consult a qualified electrician.

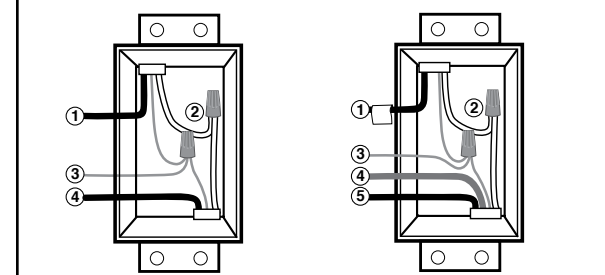

- Single Pole**
1. Line (Hot)
  2. Neutral
  3. Ground
  4. Load
- 3-Way**
1. Line or Load (see important instruction below)
  2. Neutral
  3. Ground
  4. First Traveler – note color
  5. Second Traveler – note color.
- NOTE:** For matching remote w/LEDs installation, the **First Traveler** becomes Line Hot.

**IMPORTANT :** For 3-Way applications, note that one of the screw terminals from the old switch being removed will usually be a different color (Black) or labeled Common. Tag that wire with electrical tape and identify as the common (Line or Load) in both the switch wall box and remote wall box.

**Step 3 Preparing and connecting wires:**

Pull off pre-cut insulation from timer leads. Make sure that the ends of the wires from the wall box are straight (**cut if necessary**). Remove insulation from each wire in the wall box as shown.

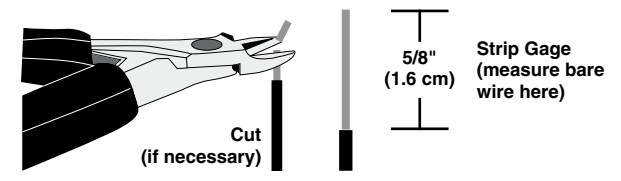

For non-standard wiring applications, refer to Wire Nut and Conductor Size Chart

WIRE NUT / # OF CONDUCTOR COMBINATION CHART	
1- #12 w/ 1 to 3 #14, #16 or #18	
2- #12 w/ 1 or 2 #16 or #18	
1- #14 w/ 1 to 4 #16 or #18	
2- #14 w/ 1 to 3 #16 or #18	

- Make sure that the ends of the wires from the wall box are straight (**cut if necessary**).
- Remove insulation from each wire in the wall box as shown.
- For **Single-Pole Application**, go to Step 4a.
- For **3-Way Coordinating Remote (no LEDs) Application**, go to Step 4b.
- For **3-Way Matching Remote (with LEDs) Application**, go to Step 4c.

**Step 4a Single Pole Wiring Application:**

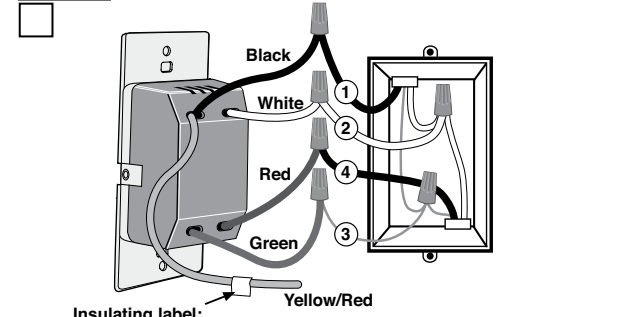

**Insulating label:** This wire is used in 3-way installations only. For single pole installations, do not remove insulating label.

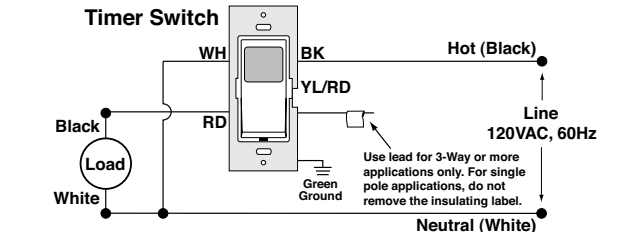

- WIRING TIMER SWITCH:**  
**Connect wires per WIRING DIAGRAM as follows:**
- Green or bare copper wire in wall box to timer switch Green lead.
  - Line Hot wall box wire to timer switch Black lead.
  - Load wall box wire to timer switch Red lead.
  - Line Neutral wall box wire to timer switch White lead.
  - **NOTE:** If label is missing place electrical tape around the timer switch Yellow/Red lead. Ensure no strands are exposed.
  - **Proceed to Step 5.**

**Step 4b 3-Way Wiring with Coordinating Remote Switch, VP0SR-10, (no LED) Application:**

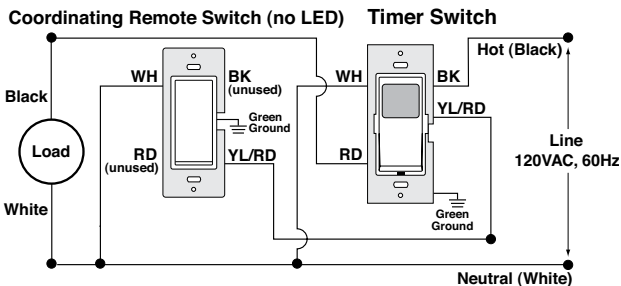
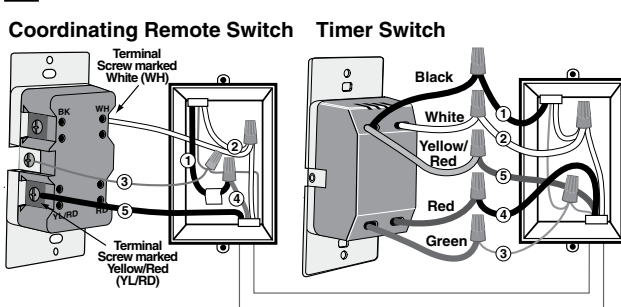

**WIRING TIMER SWITCH:**  
**Connect wires per WIRING DIAGRAM as follows:**

- NOTE:** The timer switch must be installed in a wall box that has a Line Hot connection.
- NOTE:** Maximum wire length from timer switch to all installed remotes cannot exceed 300 ft (90 m).
- Green or bare copper wire in wall box to timer switch Green lead.
  - Line Hot (common) wall box wire identified (tagged) when removing old switch to timer switch Black lead.
  - First Traveler wall box wire to timer switch Red lead (**note wire color**).
  - Remove Red insulating label from timer switch Yellow/Red lead.
  - Second Traveler wall box wire to the Yellow/Red lead (**note wire color**). This traveler from the timer switch must go to the terminal screw on the remote marked "YL/RD".
  - Line Neutral wall box wire to timer switch White lead.

**WIRING COORDINATING REMOTE SWITCH (VP0SR-10):**  
**Connect wires per WIRING DIAGRAM as follows:**

- NOTE:** "BK" and "RD" terminals on coordinating remote switch are unused. Tighten both screws.
- NOTE:** Maximum wire length from timer switch to last remote cannot exceed 300 ft (90 m).
- Green or bare copper wire in wall box to Green terminal screw.
  - Load wall box wire identified (tagged) when removing old switch to First Traveler (**note color as above**).
  - Second Traveler wall box wire (**note color as above**) to terminal screw marked "YL/RD". This traveler from the remote must go to the Yellow/Red lead on the timer switch.
  - Remove White insulating label from terminal screw marked "WH".
  - Line Neutral wall box wire to terminal screw marked "WH".
  - **Proceed to Step 5.**

**Step 4c 3-Way Wiring with Matching Remote Switch, VP0SR-1L, (w/LED) Application:**

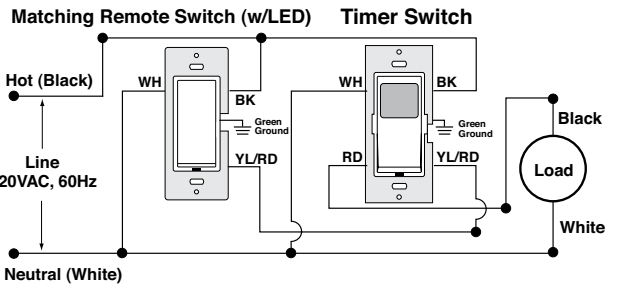
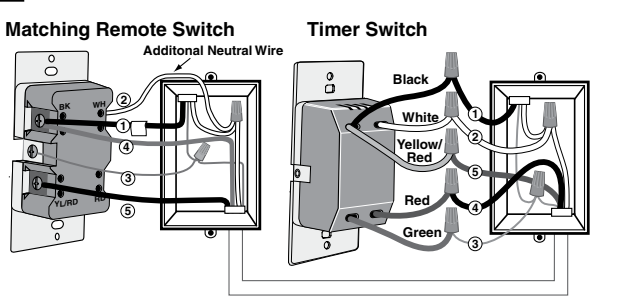

**NOTE:** The timer switch **must** be installed in a wall box that has a Load connection. The matching remote **must** be installed in a wall box with a Line Hot connection and a Neutral connection. A Neutral wire to the matching remote needs to be added as shown.

If you are unsure about any part of these instructions, consult an electrician.

**NOTE:** Maximum wire length from dimmer to all installed remotes cannot exceed 300 ft (90 m).

**WIRING MATCHING REMOTE SWITCH, VP0SR-1L (wall box with Line Hot connection):**  
**Connect wires per WIRING DIAGRAM as follows:**

- Green or bare copper wire in wall box to Green terminal screw.
- Line Hot (common) wall box wire identified (tagged) when removing old switch and First Traveler to remote terminal screw marked "BK".
- Second Traveler wall box wire from switch to remote terminal screw marked "YL/RD" (**note wire color**). This traveler from the remote must go to the Yellow/Red lead on the timer switch.
- Line Neutral wall box wire to remote terminal screw marked "WH".

**WIRING TIMER SWITCH (wall box with Load connection):**  
**Connect wires per WIRING DIAGRAM as follows:**

- Green or bare copper wire in wall box to timer switch Green lead.
- Load wall box wire identified (tagged) when removing old switch to timer switch Red lead.
- First Traveler Line Hot to timer switch Black lead.
- Remove Red insulating label from Yellow/Red lead.
- Second Traveler wall box wire (**note color as above**) to timer switch Yellow/Red lead. This traveler from the switch must go to the terminal screw on the remote marked "YL/RD".
- Line Neutral wall box wire to timer switch White lead.
- **Proceed to Step 5.**

**Step 5 Testing your Switch prior to mounting in wall box:**

- Position all wires to provide room in outlet wall box for device.
- Ensure that the word "TOP" is facing up on device strap.
- Partially screw in mounting screws in wall box mounting holes.

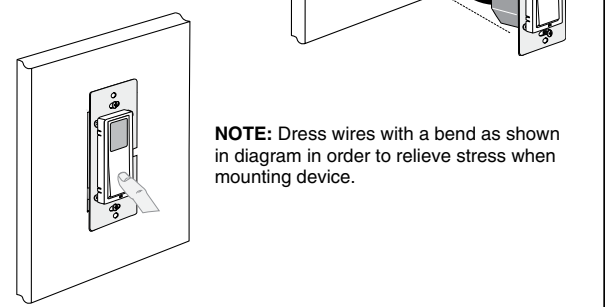

**NOTE:** Dress wires with a bend as shown in diagram in order to relieve stress when mounting device.

- Restore power at circuit breaker or fuse.
  - Wait until **LED** or time is displayed on the screen.
  - Press pad until locator light is OFF. Load should turn ON.
- If loads do not turn ON, refer to the TROUBLESHOOTING section.**

**Step 6 Switch Mounting:**  
**TURN OFF POWER AT CIRCUIT BREAKER OR FUSE.**

- Installation may now be completed by tightening mounting screws into wall box. Attach wallplate.

**Step 7 Restore Power:**  
 Restore power at circuit breaker or fuse.  
**Installation is complete.**

**NOTE:** The Digital Timer Switch is equipped with an internal rechargeable battery back-up to keep programmed settings in the event of a power interruption.

## OPERATION

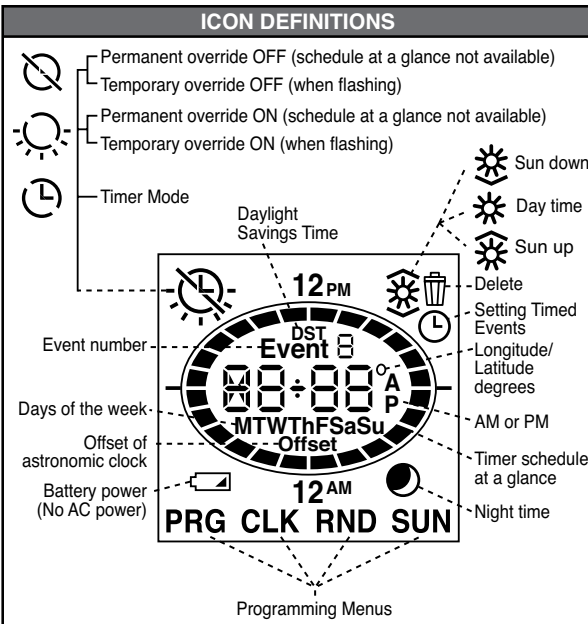

**Timer Schedule at a Glance** will allow you to quickly see your timers ON/OFF settings for the day. The displayed segments represent the time(s) your load will be on. The segment representing the current time will be flashing.

**Backlit LCD display** will light up when any button is pressed and will extinguish 30 seconds after the last button press.

## PROGRAMMING GUIDE

Decide which mode is best for your application:

Pro mode **Pro** or Standard mode **Std**

**Pro Mode** provides up to 50 ON/OFF events for any day or combination of days, **M-Su**, **M-F**, or **Sa-Su** at desired fixed times or self adjusting **Sunup** and **Sundown** times. In this mode self adjusting **Daylight Savings Time** and random modes are also available.

**Std Mode** provides up to 3 ON/OFF events for **M-Su**, **M-F**, or **Sa-Su** at desired fixed times only. Self adjusting **Sunup** and **Sundown** and **Daylight Savings Time** are NOT available in Standard Mode.

To exit programming at any time press **override button** -

To program your device:

a) Perform a **System Reset** by gently lifting the VPT24 door from the bottom of the push pad until an audible click is heard. The door will stay open while you are programming the device:

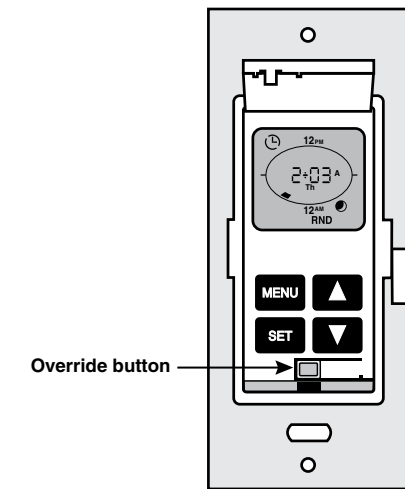

b) Press and hold **SET** followed by **Override** until **DEL** stops flashing and **5-0** flashes (approximately 5 seconds). Press **SET** to confirm device **Reset**.

c) Product will go through a brief self test and then **DEL** will begin to flash. Choose **Pro** or **Std** by using **▲** or **▼** until the selected mode appears and pressing **SET** to confirm your choice.

d) Continue to the programming section for the Mode chosen.

## PROGRAMMING PRO MODE

1. **Setting up the Time, Daylight Savings Time Option and the Date:**

- 12** will be flashing. Press **▲** or **▼** to select the hour and press **SET** to confirm your choice.
- 00** will be flashing. Press **▲** or **▼** to select the minutes and press **SET** to confirm your choice.
- A** or **P** will be flashing. Press **▲** or **▼** to select **A** for **AM** or **P** for **PM** and press **SET** to confirm your choice.
- OFF** will be flashing. Set the daylight savings time mode to **OFF** or **AUTO (for automatic adjustment of daylight savings time)** by using **▲** or **▼** to choose daylight savings time option and press **SET** to confirm your choice.

**NOTE:** Daylight Savings Time shall start at 2am on the second Sunday of March (add one hour) and end at 2am on the first Sunday of November (subtract one hour).

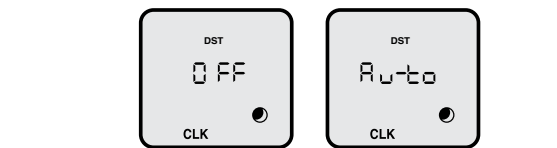

- 09** will be flashing. Use **▲** or **▼** to choose the year and press **SET** to confirm your choice.
- 01** will be flashing. Use **▲** or **▼** to choose the month and press **SET** to confirm your choice.
- 01** will be flashing. Use **▲** or **▼** to choose the date and press **SET** to confirm your choice. The day of week will automatically adjust.

2. **Programming your Timer Options:**

- a) **Setting Sunup, Sundown, desired Offset Time and Time Zone:**
- Sunup** and **Sundown** are automatically adjusted using the latitude and longitude coordinates of your location. To obtain these coordinates go to [www.leviton.com/VPT24](http://www.leviton.com/VPT24) and click on **Longitude/Latitude Coordinates Lookup...** Type in your home address and press enter. Your latitude (N) and longitude (W) coordinates will be shown on the screen. Write down only the 2 or 3 digit number. Disregard a negative symbol (-) if it precedes the number.

The time zones are limited to the North American Continent. The options you are presented are determined via your longitude in the chart below:

Longitude	Time Zone
60° - 80°	Eastern
81° - 95°	Eastern, Central
96° - 110°	Central, Mountain
111° - 135°	Mountain, Pacific, Alaskan
136°-143°	Pacific, Alaskan, Hawaii-Aleutian
144°+	Alaskan, Hawaii-Aleutian

- On your timer press **MENU** until **SUN** appears at the bottom of the screen and press **SET** to confirm your choice.
- Use **▲** or **▼** to choose your latitude (N) and press **SET** to confirm your choice.
- Use **▲** or **▼** to choose your longitude (W) and press **SET** to confirm your choice.
- 0:00** will be flashing to represent the offset time. Choose the amount of time, if any, to turn the load ON/OFF before or after **Sunup** and **Sundown** by pressing **▲** to add time to the **Sunup/Sundown** time and use **▼** to subtract time from the **Sunup/Sundown** time. Press **SET** to confirm your choice (up to 3 hours and 59 minutes).
- 0:00** will appear. The time zone closest to the coordinates you entered will flash. Press **SET** if this is correct. If this is not correct use **▲** or **▼** to choose your time zone and press **SET** to confirm your choice.

b) **Setting ON/OFF Events:**

- Press **MENU** until **PRG** is in the lower left corner. Press **SET** to enter the programming mode.
- Event 1** will be flashing. Press **SET** to choose this event or use **▲** to move to the next event and press **SET** to confirm your event number choice.

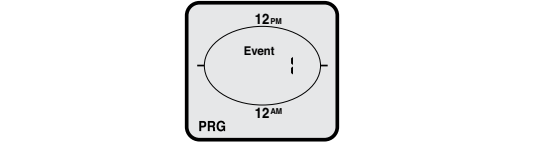

- All days of the week will be flashing. Press **SET** to choose all days of the week or use **▲** or **▼** to scroll through **M-F**, **Sa-Su**, any single day or combination of days. **NOTE:** To choose a combination of days press **SET** after each day you want and then move on to the next day by pressing **▲** or **▼**. Continue to scroll using **▲** until **PRG** flashes.

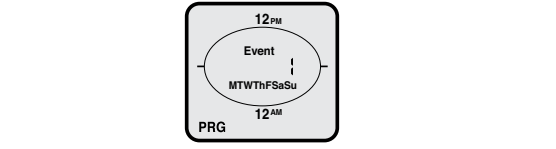

- When done choosing the desired days **PRG** in the lower left corner will flash. Press **SET** to confirm the chosen days and continue on to choosing the event **TURN ON TIME**.

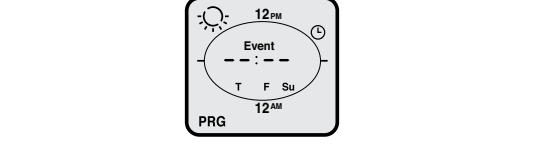

- At **---** use **▲** or **▼** to choose **---** for time, **Sundn** for **Sundown**, **Sunup** for **Sunup** or **DEL** to delete an existing program and press **SET** to confirm your choice.
- If **---** is chosen, use **▲** or **▼** to choose the hour and press **SET** to confirm your choice. Do the same for minutes.
- At **6:00P** press **SET** to choose a **TURN OFF TIME** or use **▲** or **▼** to choose **Sundn** for **Sundown**, **Sunup** for **Sunup** or **DEL** to delete an existing program and press **SET** to confirm your choice.
- If **---** is chosen, use **▲** or **▼** to choose the hour and press **SET** to confirm your choice. Do the same for minutes.
- Continue to set desired events in the same manner. When this is done press **█** to escape out of programming. If no buttons are pressed after approximately 30 seconds the device will automatically exit out of programming mode.

## PROGRAMMING STANDARD MODE

To set the clock:

- 12** will be flashing. Use **▲** or **▼** to choose the hours. Press **SET** to confirm your choice.
- The minutes will be flashing. Use **▲** or **▼** to choose the minutes. Press **SET** to confirm your choice.
- A** for **AM** or **P** for **PM** will be flashing. Use **▲** or **▼** to choose the **A** or **P**. Press **SET** to confirm your choice.
- The day of the week will be flashing. Use **▲** or **▼** to choose the day. Press **SET** to confirm your choice.

To set ON/OFF Events:

- Press **MENU** until **PRG** is in the lower left corner. Press **SET** to enter the programming mode.
- Event 1** will be flashing. Press **SET** to choose this event or use **▲** to move to the next event and press **SET** to confirm your event number choice.
- All days of the week will be flashing. Press **SET** to choose all days of the week or use **▲** or **▼** to scroll through **M-F** and **Sa-Su**. Press **SET** to confirm your days of the week choice and continue to program the event **ON TIME**.
- At **---** use **▲** or **▼** to choose **---** for time, or **DEL** to delete an existing program and press **SET** to confirm your choice.
- Use **▲** or **▼** to choose the hour and press **SET** to confirm your choice. Do the same for minutes and press **SET** to confirm your choice. Continue to program the event **OFF TIME**.
- At **6:00P** press **SET** to choose the **OFF TIME** or use **▲** or **▼** to choose **DEL** to delete an existing program and press **SET** to confirm your choice.
- Continue to set desired events in the same manner. When you are done press **█** to escape out of programming. If no buttons are pressed after approximately 30 seconds the device will automatically exit out of programming mode.

## TIMER OVERRIDES

- Activate Temporary Override by pressing the push pad to toggle the load (ON to OFF or OFF to ON).
- Activate Permanent Override by pressing and holding the push pad for several seconds to maintain the load in the current state (either ON or OFF).

## CHANGING SETTINGS

- Press **MENU** until **CLK** appears at the bottom of the screen **CLK**. Press **SET** to enter this mode. Adjust the clock using **▲** or **▼** and pressing **SET** after each setting.

Turning Random Mode ON/OFF (Pro Mode ONLY):

This function will add or subtract anywhere from 1 to 20 minutes to each selected **ON** and **OFF** time to create a random pattern.

- Press **MENU** until **RND** appears at the bottom of the screen and press **SET** to enter this mode.
- Use **▲** or **▼** to toggle between **OFF** and **ON** and press **SET** to confirm your choice.

## DELETE ALL EVENTS

If at any time you want to delete all of your programmed events, you can perform a **DELETE ALL EVENTS** function:

- Gently lift the VPT24 door from the bottom of the push pad until an audible click is heard.
- Press and hold **SET** followed by **Override** until **DEL** stops flashing. Upon releasing both buttons all events will be deleted and the **Timer Schedule at a Glance** will appear with only the current time segment flashing.

## USE IN MULT-LOCATION APPLICATIONS

When using a remote switch(es) with your vizia +™ 24 hour timer you will be able to activate the temporary override or the permanent override from the remote switch. To activate or deactivate the temporary override press the push pad on the remote switch. To activate permanent override press and hold the remote switch push pad. Either of these actions will toggle the state of the load.

## TROUBLESHOOTING

- Lights flickering or intermittent power to load**
  - Load has a bad connection.
  - Wires not secured firmly with wire connectors of timer switch or terminal screws of remote.
- Load does not turn ON and Locator LED does not turn ON**
  - Circuit breaker or fuse has tripped.
  - Load is burned out.
  - Load Neutral connection is not wired.
- Remote does not operate lights**
  - Ensure that total wire length does not exceed 300 ft (90 m).

For additional information, contact Leviton's Techline at 1-800-824-3005 or visit Leviton's website at [www.leviton.com](http://www.leviton.com)

This product is covered by U.S. Patent No. D634,276 and corresponding foreign patents.

- Degree of protection provided: IPX0
- Type of Action: 1CS

## FCC COMPLIANCE STATEMENT

This device complies with Part 15 of the FCC Rules. Operation is subject to following two conditions: (1) this device may not cause harmful interference, and (2) this device must accept any interference received, including interference that may cause undesired operation of the device.

This equipment has been tested and found to comply with the limits for a Class B Digital Device, pursuant to Part 15 of the FCC Rules. These limits are designed to provide reasonable protection against harmful interference in a residential installation. This equipment generates, uses, and can radiate radio frequency energy and, if not installed and used in accordance with the instructions, may cause harmful interference to radio communications. However, there is no guarantee that interference will not occur in a particular installation. If this equipment does cause harmful interference to radio or television reception, which can be determined by turning the equipment OFF and ON, the user is encouraged to try to correct the interference by one or more of the following measures:

- Reorient or relocate the receiving Antenna.
- Increase the separation between the equipment and the receiver.
- Connect the equipment into an outlet on a circuit different from that to which the receiver is connected.
- Consult the dealer or an experienced radio/tv technician for help.

## FCC CAUTION

Any changes or modifications not expressly approved by Leviton Manufacturing Co., Inc., could void the user's authority to operate the equipment.

## FOR CANADA ONLY

For warranty information and/or product returns, residents of Canada should contact Leviton in writing at **Leviton Manufacturing of Canada Ltd to the attention of the Quality Assurance Department, 165 Hymus Blvd, Pointe-Claire (Quebec), Canada H9R 1E9** or by telephone at **1 800 405-5320**.

## LIMITED 5 YEAR WARRANTY AND EXCLUSIONS

Leviton warrants to the original consumer purchaser and not for the benefit of anyone else that this product at the time of its sale by Leviton is free of defects in materials and workmanship under normal and proper use for five years from the purchase date. Leviton's only obligation is to correct such defects by repair or replacement, at its option, if within such five year period the product is returned prepaid, with proof of purchase date, and a description of the problem to **Leviton Manufacturing Co., Inc., Att: Quality Assurance Department, 201 North Service Road, Melville, New York 11747**. This warranty excludes and there is disclaimed liability for labor for removal of this product or reinstallation. This warranty is void if this product is installed improperly or in an improper environment, overloaded, misused, opened, abused, or altered in any manner, or is not used under normal operating conditions or not in accordance with any labels or instructions. **There are no other or implied warranties of any kind, including merchantability and fitness for a particular purpose, but if any implied warranty is required by the applicable jurisdiction, the duration of any such implied warranty, including merchantability and fitness for a particular purpose, is limited to five years. Leviton is not liable for incidental, indirect, special, or consequential damages, including without limitation, damage to, or loss of use of, any equipment, lost sales or profits or delay or failure to perform this warranty obligation.** The remedies provided herein are the exclusive remedies under this warranty, whether based on contract, tort or otherwise.

WEB VERSION