

# AZELIA 3260 SHOWER DOOR

## LOT #0 - LOT #1



Picture : Lot #1

**Lot #0**  
Technical drawing on page 2

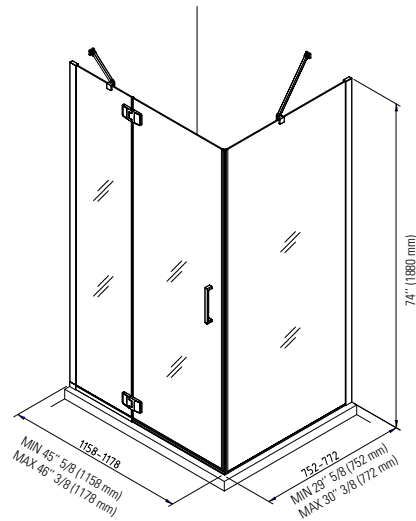

**Lot #1**  
Technical drawing on page 3

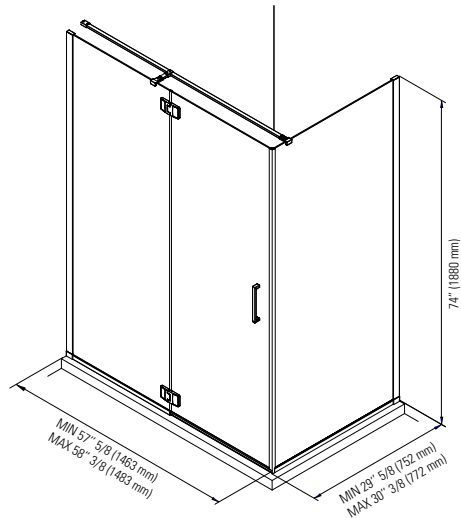

### PRODUCT DESCRIPTION:

Contemporary style  
Front and return glass panels  
6 mm glass (1/4")  
Door opening 26 1/8"  
right or left corner installation  
Offered in chrome/clear

24-48hrs

### BOXES SIZE:

77" x 34" x 3"

### NET WEIGHT:

155 lbs

### GROSS WEIGHT

155 lbs

\* Produits Neptune applies a cutting-edge protective covering, which repels water and dirt for easy cleaning and increases the lifespan of your shower doors.



**Certification ECORESPONSIBLE**  
First manufacturer of bathroom products in North America to be certified ecoresponsible.



**Produits Neptune**

ENTREPRENEUR

6835, Picard street, Saint-Hyacinthe (Quebec) J2S 1H3  
Phone: (450) 773-7058 - Fax: (450) 773-5063  
produitsneptune.com

REV: 07-18



Produits Neptune

## AZELIA 3260 - LOT #0

Shower door

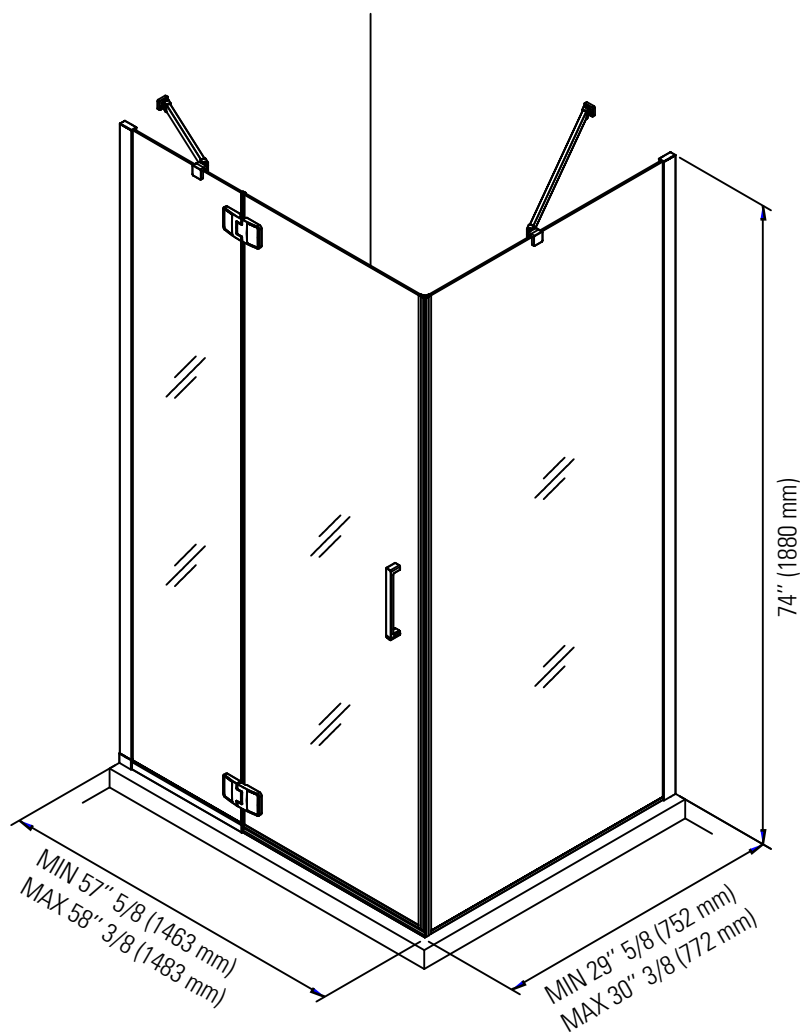

\*All dimensions are approximate and subject to change without notice.  
Please refer to the installation guide before beginning the installation.



Produits Neptune

## AZELIA 3260 - LOT #1

Shower door

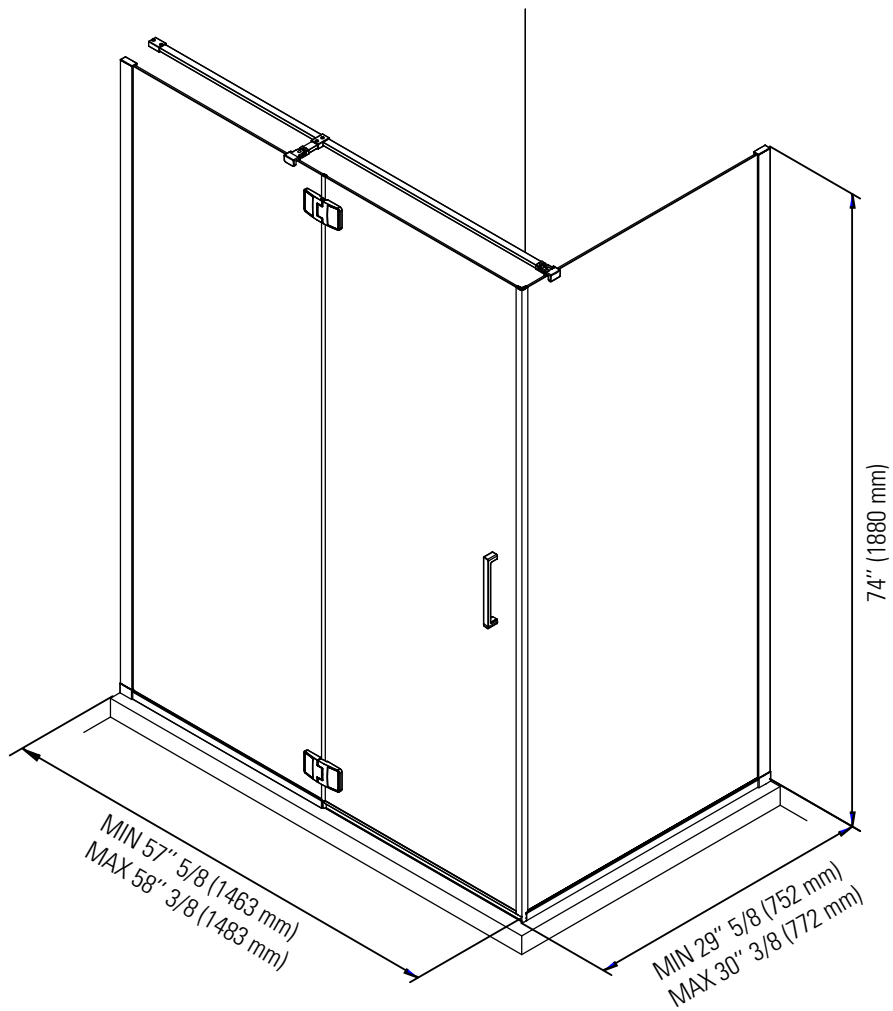

\*All dimensions are approximate and subject to change without notice.  
Please refer to the installation guide before beginning the installation.