



Sink - MEM

Wall-mounted single-lever mixer with cover plate without drain - polished chrome

Article number: 36 865 782-00 0010



- 9-3/4" Projection
- Rigid spout
- Rectangular aerated stream
- Spout hole diameter 1-1/2"
- Hole diameter single-lever mixer 2-1/4"
- Cover plate 3-1/8" x 7-1/8"
- Water flow rate limited to max. 1.2 gpm
- lead-free
- (ADA)



polished chrome

Accessory is required for this item.

Dimensional drawing

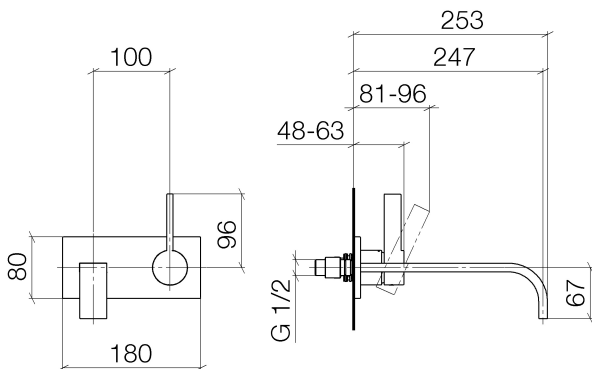



Sink - MEM

Wall-mounted single-lever mixer with cover plate without drain - polished chrome

Article number: 36 865 782-00 0010

All dimensions in mm / inch = mm x 0,0394

Flow rate chart

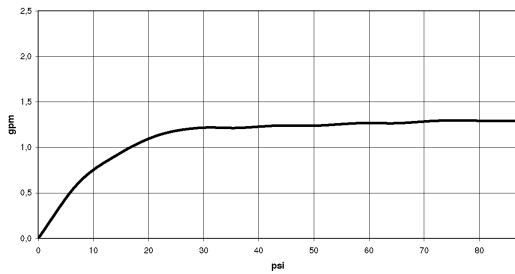



Sink - MEM

Wall-mounted single-lever mixer with cover plate without drain - polished chrome

Article number: 36 865 782-00 0010

Other surface finishes



platinum matte

36 865 782-06 0010



platinum

36 865 782-08 0010



Brushed Durabronze

36 865 782-28 0010



Dark Platinum matte

36 865 782-99 0010

More custom finish options are available via special production (xTra Service). Please see our finish matrix for availability and pricing or contact a Dornbracht representative.

Required article



35 860 970-90 0010

Rough for wall-mounted
faucet mixer on right -

Sink - MEM

Wall-mounted single-lever mixer with cover plate without drain - polished chrome

Article number: 36 865 782-00 0010

Spare parts list

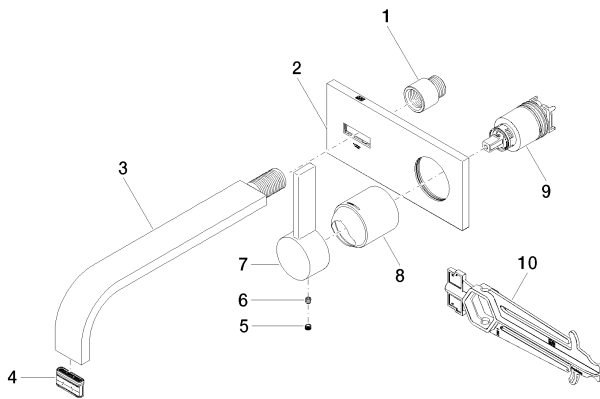

Number	Item Number	Designation	Number of units
1	09 24 03 072 10 90	nipple	1
2	90 11 01 170 00-00	plate	1
3	04 28 22 148 10-00	spout	1
4	90 29 03 118 00 90	aerator	1
5	09 31 20 109 90	plug	1
6	09 31 11 030 90	pin	1
7	09 20 78 058-00	handle	1
8	09 11 02 288-00	cover	1
9	90 15 05 064 01 90	cartridge	1
10	09 30 09 064 90	key	1